

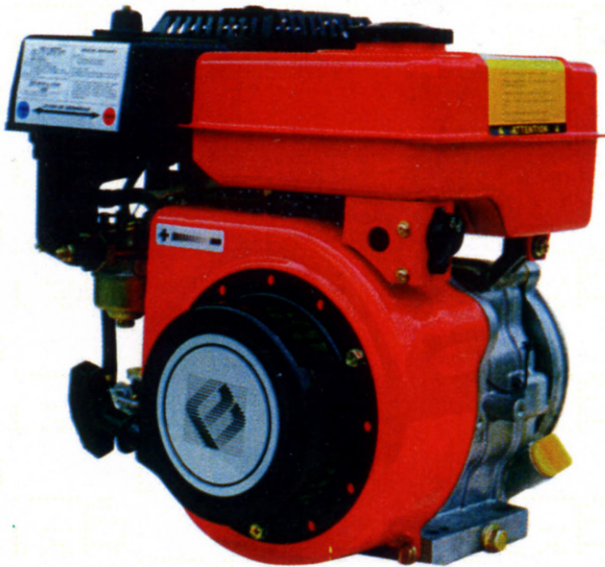

MOTEUR INDUSTRIEL OHV ESSENCE 6 CH



■ Équipements de réduction du bruit et des vibrations :

- silencieux en série
- cylindre incliné
- pignonerie hélicoïdale

■ Sécurité d'huile montée en série.

■ Reduced noise and vibrations equipments :

- equipped with exhaust muffler
- inclined cylinder
- helicoid gear and camshaft assembly

■ Equipped with oil level switch.

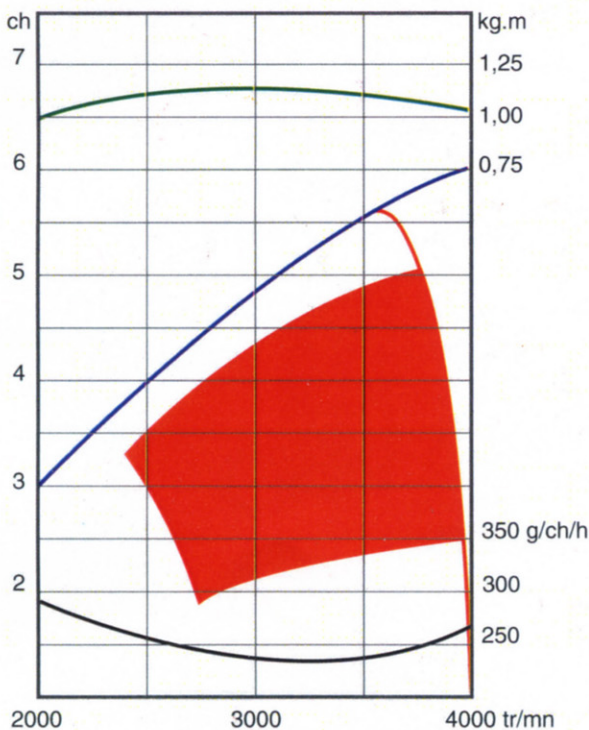

- Zone de regime recommandé / *recommended operating range*
- COUPLE (kg.m) / *torque (rpm)*
- PUISSANCE (ch) / *output power (HP)*
- consommation (g/ch/h) / *fuel consumption (g/HP/h)*

INFORMATIONS TECHNIQUES

TYPE	monocylindre 4 temps - soupapes en tête (OHV) axe horizontal - essence (avec ou sans plomb)
CYLINDRE	aluminium, chemise fonte, réalésable
VILEBREQUIN	fonte traitée monté sur roulement
REFROIDISSEMENT	par air forcé
LUBRIFICATION	par barbotage
ALLUMAGE	électronique
SENS DE ROTATION	anti-horaire (côté sortie)
DÉCOMPRESSION	mécanique centrifuge
RÉGULATION	mécanique centrifuge
DÉMARRAGE	lanceur à enroulement automatique
RÉSERVOIR	tôle avec jauge et filtre
FILTRE À AIR	double élément (mousse + cartouche)

TECNICAL DATA

TYPE	single cylinder 4 stroke OHV gasoline engine (with or without lead) - horizontal shaft
CYLINDER	aluminium, cast-iron cylinder liner, reboreable
CRANKSHAFT	chilled cast-iron fitted on bearing
COOLING	air cooled
LUBRIFICATION	splashing
IGNITION	transistor controlled
ROTATION	anticlockwise
DÉCOMPRESSION	centrifugal mechanic type
GOVERNOR SYSTEM	centrifugal mechanic type
STARTING SYSTEM	recoil starter
TANK	metal tank with gauge and filter
AIR CLEANER	dual element (moss and cartridge)



TYPE engine type	4 temps/stroke OHV	CAPACITÉ DU RÉSERVOIR fuel tank capacity	4,0 L
CYLINDRÉE displacement	179 cm³ - cc	CONSOMMATION D'ESSENCE fuel consumption	306 g/kW/h (230 g/HP/h)
TAUX DE COMPRESSION compression ratio	8,0 : 1	CAPACITÉ D'HUILE oil capacity	0,7 L
ALÉSAGE X COURSE cylinder bore x stoke	69 x 48 mm	DIMENSIONS L x P x H dimension L x W x H	275 x 350 x365 mm
PUISSANCE MAXIMUM maximum output power	6 ch-HP (4,4 kW) 3600 tr/mn-rpm	NIVEAU DE BRUIT (7 m) noise rate (7 m)	75 dBA 3600 tr/mn-rpm
COUPLE MAXIMUM maximum torque	1,2 kgm (12,3Nm) 2800 tr/mn-rpm	POIDS À SEC dry weight	17 kg

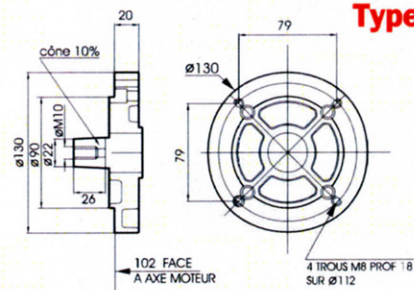
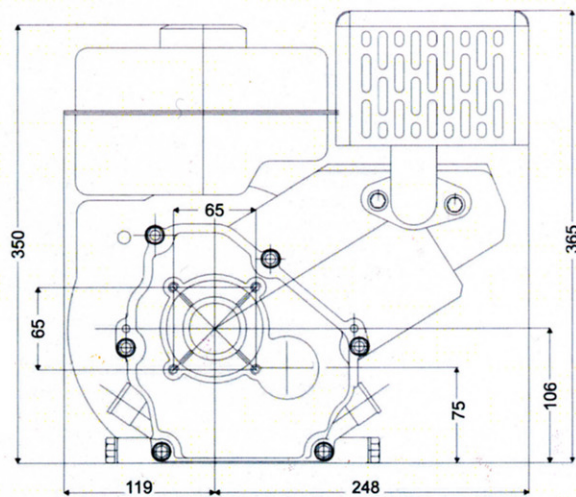

Type 1813001

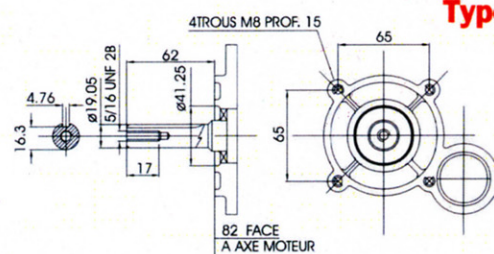

Type 1813111

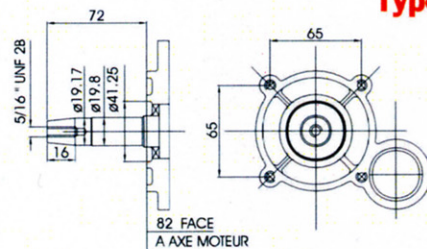
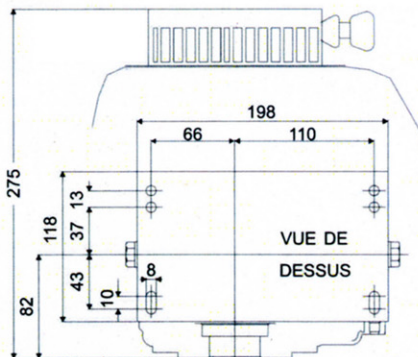

Type 1813411

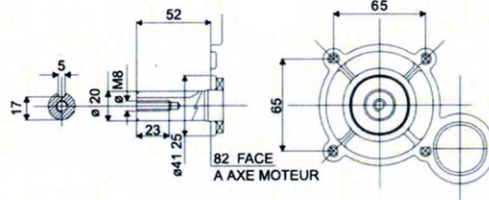

Type 1813511

Les spécifications peuvent être modifiées sans préavis et n'engagent pas **Bernard moteurs**



BERNARD
moteurs

Votre revendeur spécialisé

Z.I. • Avenue Ampère • Gretz-Armainvilliers
77223 TOURNAN CEDEX • FRANCE
Téléphone : 01.64.07.27.27 • Télécopie : 01.64.07.28.64
e-mail : bernard.moteurs@wanadoo.fr